

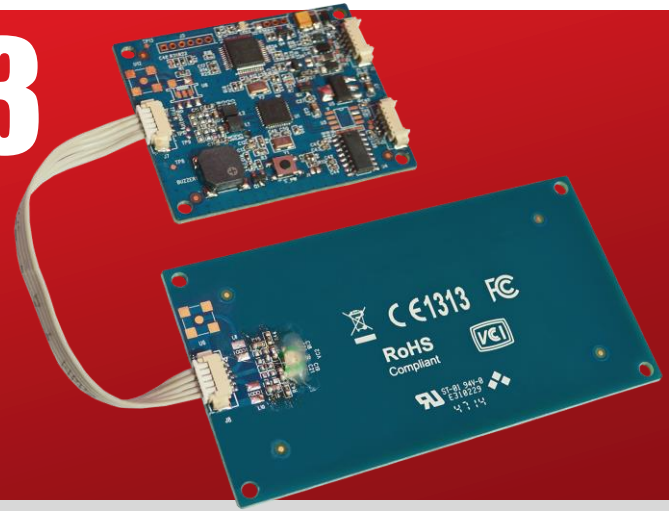

Advanced Card Systems Ltd.
Card & Reader Technologies

ACM1252U-Y3

USB NFC Reader Module with Detachable Antenna Board



User Manual V1.02



Table of Contents

1.0.	Introduction	3
2.0.	Detachable Antenna	4
3.0.	PIN Assignment	6
3.1.	LED Configuration	6
3.1.1.	LED for Power status	7
3.1.2.	LED for smart card operation status	7
3.1.3.	Default LED Behaviors	7
3.2.	Connect ACM1252U-Y to another device via USB	8
4.0.	Minimum Distances from Conductive Materials.....	10
Appendix A. Connector Specification.....		11

List of Figures

Figure 1 :	ACM1252U-Y Main Board	4
Figure 2 :	ACM1252U-Y Antenna Board.....	5
Figure 3 :	ACM1252U-Y LED Configuration	6
Figure 4 :	ACM1252U-Y LED Circuit.....	7
Figure 5 :	ACM1252U-Y USB Configuration	9
Figure 6 :	ACM1252U-Y USB Connector (Male) Specification	11
Figure 7 :	ACM1252U-Y Cable Connector (Female) Specification.....	11

List of Tables

Table 1 :	Recommended Minimum Distances from Conductive Materials.....	10
------------------	---	-----------



1.0. Introduction

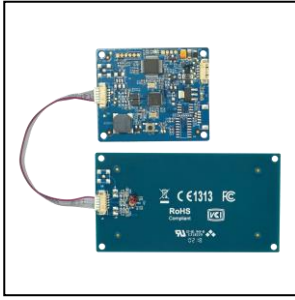

The ACM1252U-Y USB NFC Reader Module with Detachable Antenna Board is developed based on the 13.56 MHz contactless technology. Like its predecessor, the ACR1252U NFC Forum–Certified Reader, ACM1252U-Y supports all three NFC modes (card reader/writer, card emulation, and peer-to-peer communication). This Smart Card Reader Module is designed for fast and easy integration to embedded systems.

The ACM1252U-Y supports ISO 14443 Type A and B cards, and MIFARE®, FeliCa, and ISO 18092–compliant NFC tags. It also supports other NFC devices with an access speed of up to 424 Kbps and proximity operating distance of up to 50mm (depending on tag type used). Post-

deployment firmware upgrade is also supported, eliminating the need for additional hardware modification.

The ACM1252U-Y comes with a detachable antenna and an optional USB cable making it the perfect front-end interface module to enable NFC transactions for applications involving vending machine payment systems, kiosks, gaming machines and other integrated systems.

2.0. Detachable Antenna

The ACM1252U is designed to offer a detachable antenna board that will best fit the embedded system. The detachable antenna board may be connected to any front-end interface module to enable NFC transactions.

To do this:

1. Connect antenna cable to **J7** of ACM1252U-Y main board (see **Figure 1**).

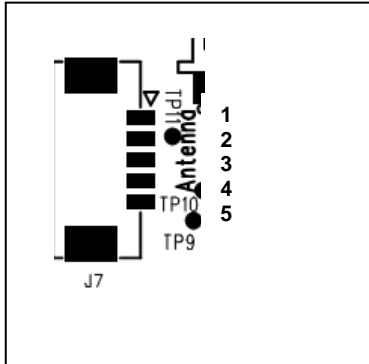

- 1 GND
- 2 ANT_1
- 3 ANT_GND
- 4 ANT_2
- 5 GND

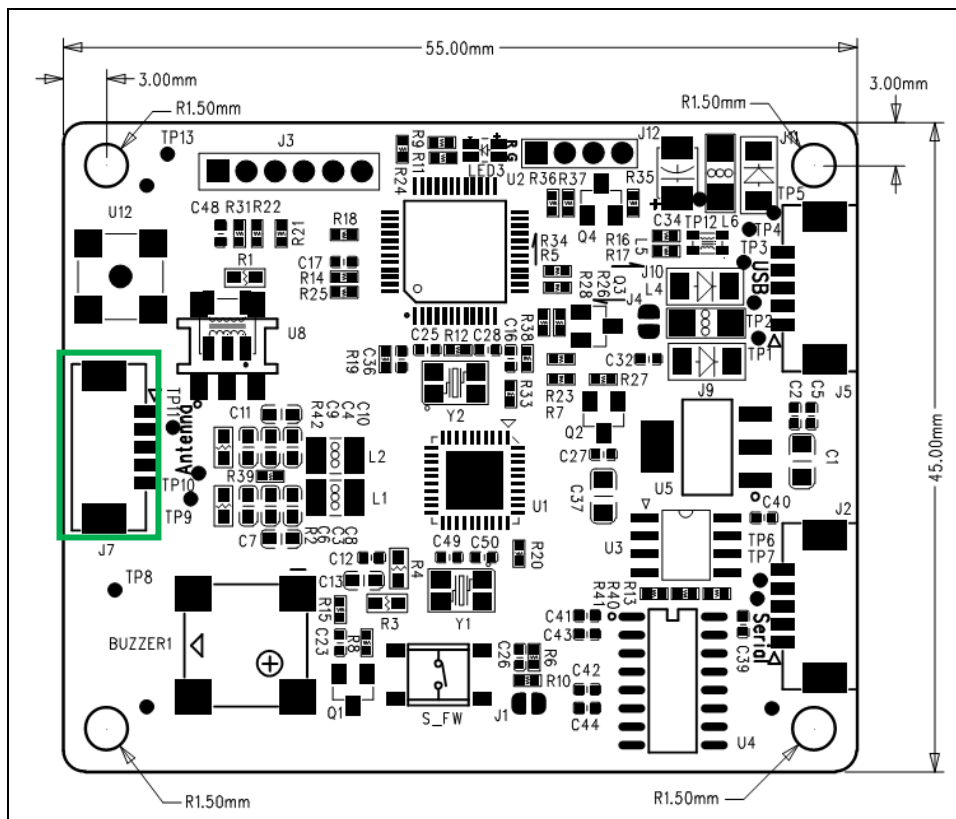
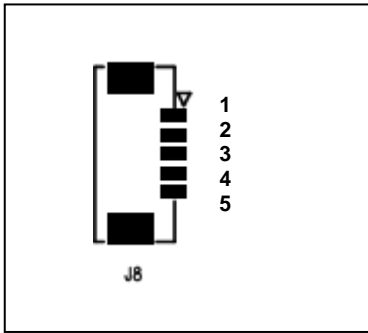

Figure 1: ACM1252U-Y Main Board

2. Connect antenna cable to **J8** of the ACM1252U-Y antenna board (see **Figure 2**).



- 1 GND
- 2 ANT_2
- 3 ANT_GND
- 4 ANT_1
- 5 GND

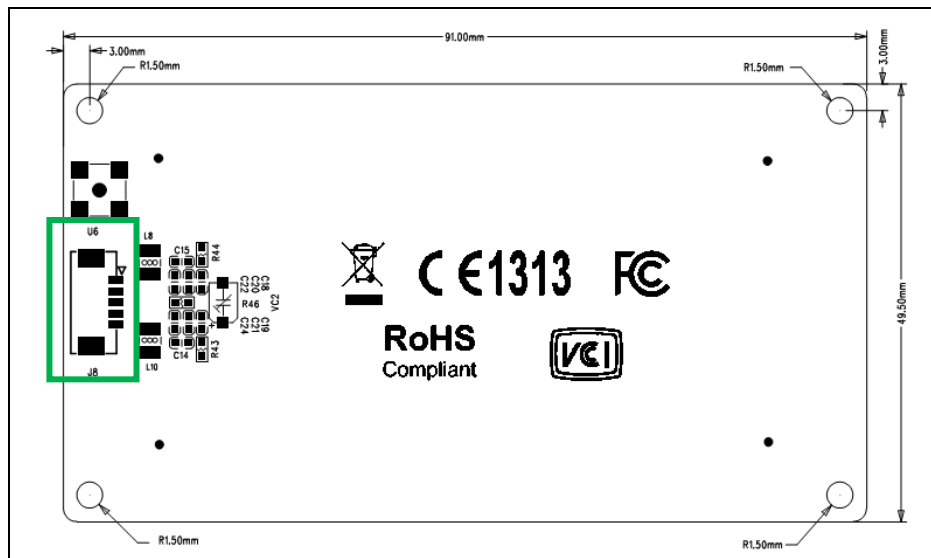

Figure 2: ACM1252U-Y Antenna Board

3.0. PIN Assignment

3.1. LED Configuration

There is a bi-color LED on ACM1252U-Y3 to display and control its operation status. These are Red and Green in which can be extended to other peripherals as well.

To do this:

1. Connect jumper to **J12** for the LED status of power and card signals (see **Figure 3** and **Figure 4**).

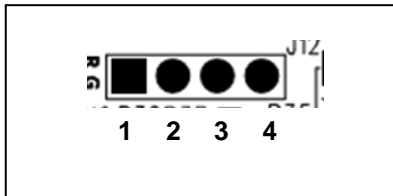

- | | |
|---|-----------|
| 1 | 3.3 V |
| 2 | Green LED |
| 3 | Red LED |
| 4 | GND |

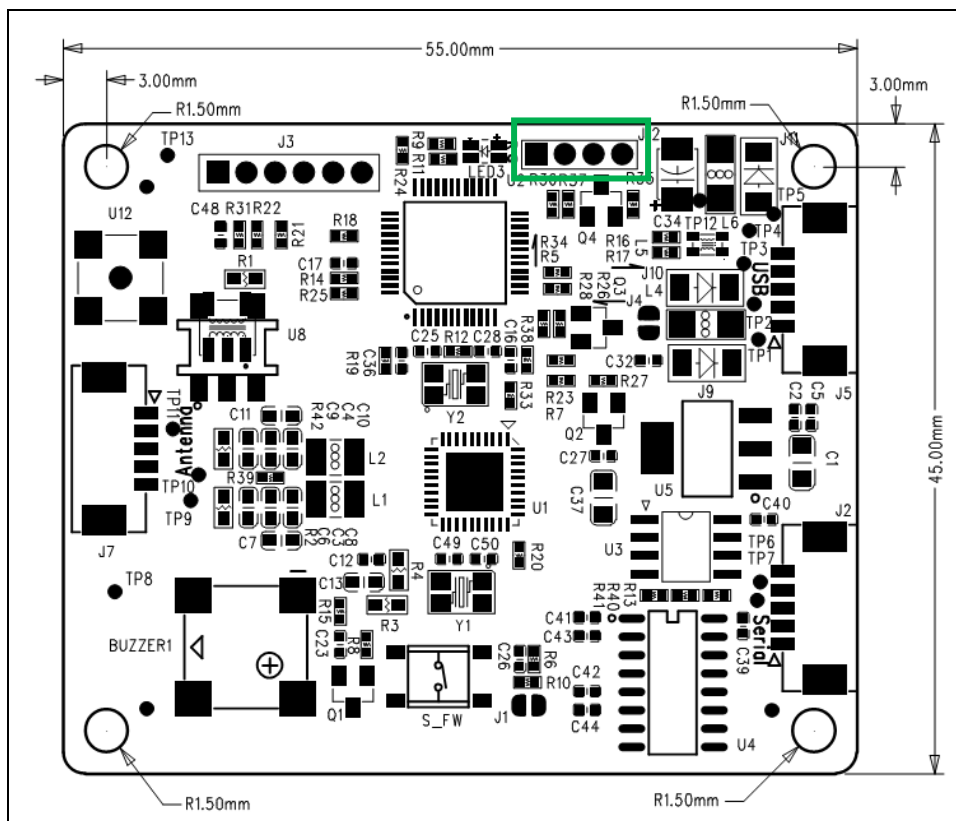

Figure 3: ACM1252U-Y LED Configuration

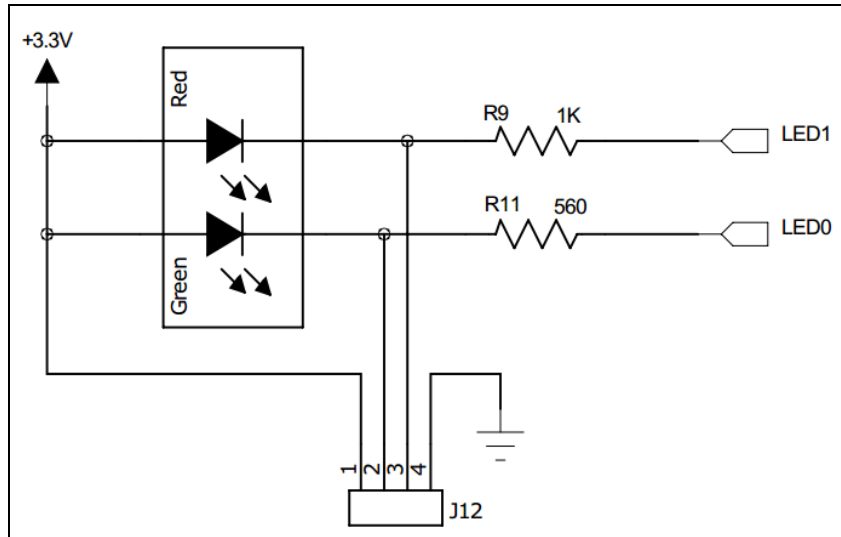

Figure 4: ACM1252U-Y LED Circuit

3.1.1. LED for Power status

The default LED settings when the power is on are Red and Green and then slow flashing Green. These LEDs cannot be controlled.

3.1.2. LED for smart card operation status

To control the LED's output and checking the LED's behavior for smart card operation status (J12), please refer to ACM1252U Reference Manual. This reference manual will discuss the detail how PC/SC APDU commands were implemented for the contactless interface and device peripherals of ACM1252U.

3.1.3. Default LED Behaviors

3.1.3.1. PICC

Below shows the default LED behaviors for readers with PICC Interface.

Behavior	PICC Interface
1. Standby Mode (No Card Detected)	Green Blink (Slow – 2.5 s)
2. Card Detected	Green ON
3. Communication	Green FLASH (Fast)
Additional Remarks	Color can be changed via application (using bi-color LED) Behavior (On/Off) can be configured via app

Note: User configurable interval for LED Flashing is not recommended as it may affect polling interval.

3.1.3.2. PICC + SAM

Note: SAM slot is an optional feature.

Below is the default LED behavior for readers with PICC + SAM slots.

Behavior	PICC Interface	SAM Interface
1. Standby Mode (No Card Detected)	Green Blink (Slow – 2.5 s)	OFF
2. Card Detected	Green ON	OFF
3. Communication	Green FLASH (Fast)	N/A
Additional Remarks	Color can be changed via app (using bi-color LED) Behavior (On/Off) can be configured via application	

Note: User configurable interval for LED Flashing is not recommended as it may affect polling interval.

3.2. Connect ACM1252U-Y to another device via USB

A USB port is available to connect the ACM1252U-Y to other peripheral or device.

To do this:

1. Connect socket (**J5**) via USB cable to another peripheral device (see **Figure 5**).

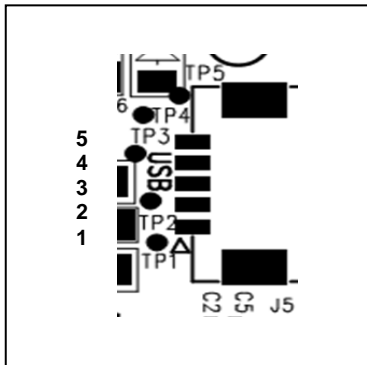

- 5 USB VCC
- 4 USB D-
- 3 USB D+
- 2 USB GND
- 1 USB shielding

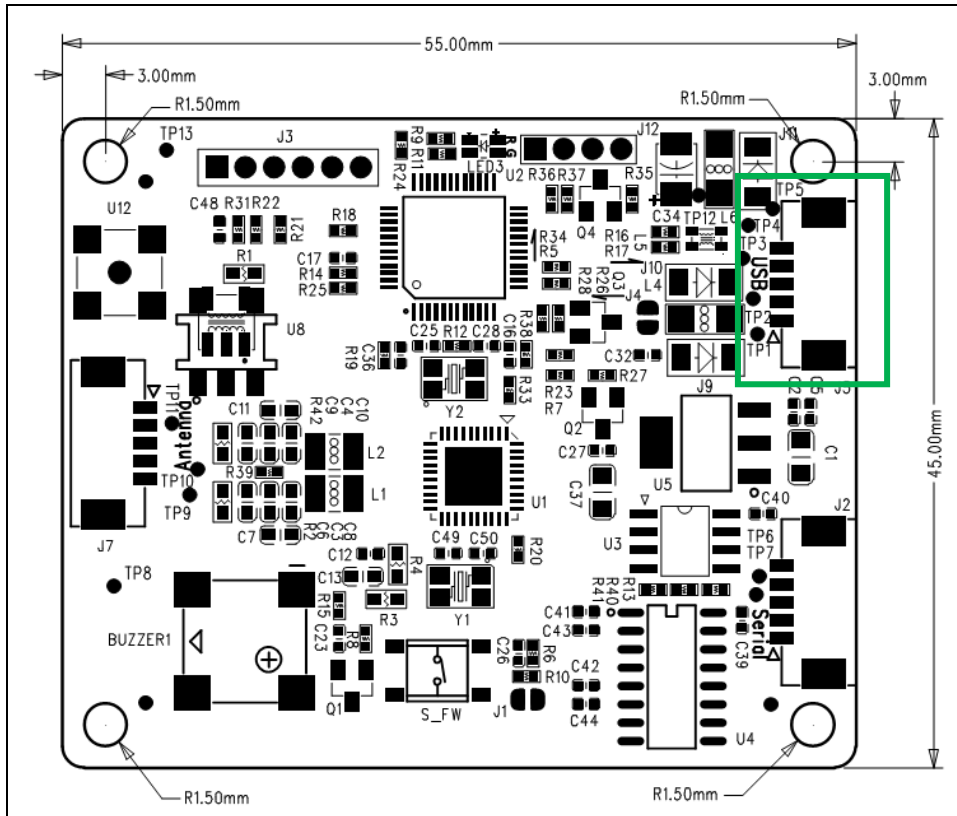
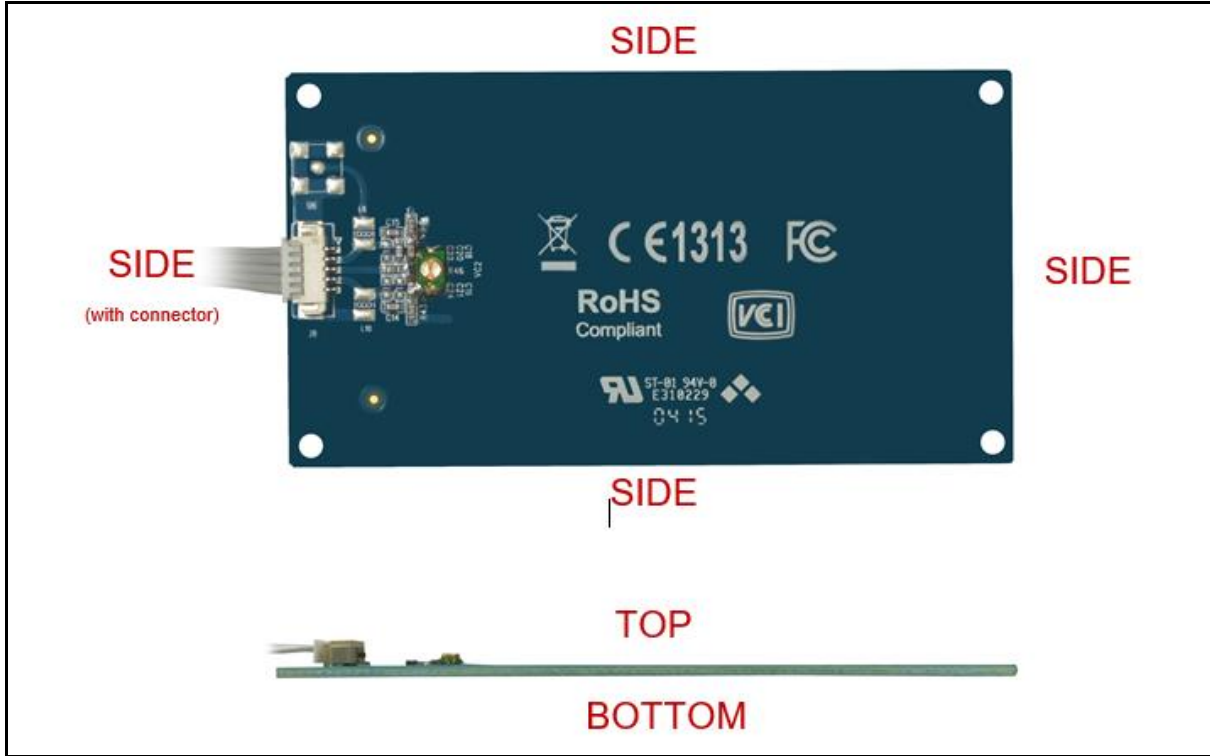

Figure 5: ACM1252U-Y USB Configuration

4.0. Minimum Distances from Conductive Materials

The table below illustrates the recommended minimum distances of the ACM1252U-Y Antenna Board from conductive materials.



Location	Minimum Distance
Sides	15 mm
Side (with connector)	5 mm
Top and Bottom	30 mm

Table 1: Recommended Minimum Distances from Conductive Materials

Appendix A. Connector Specification

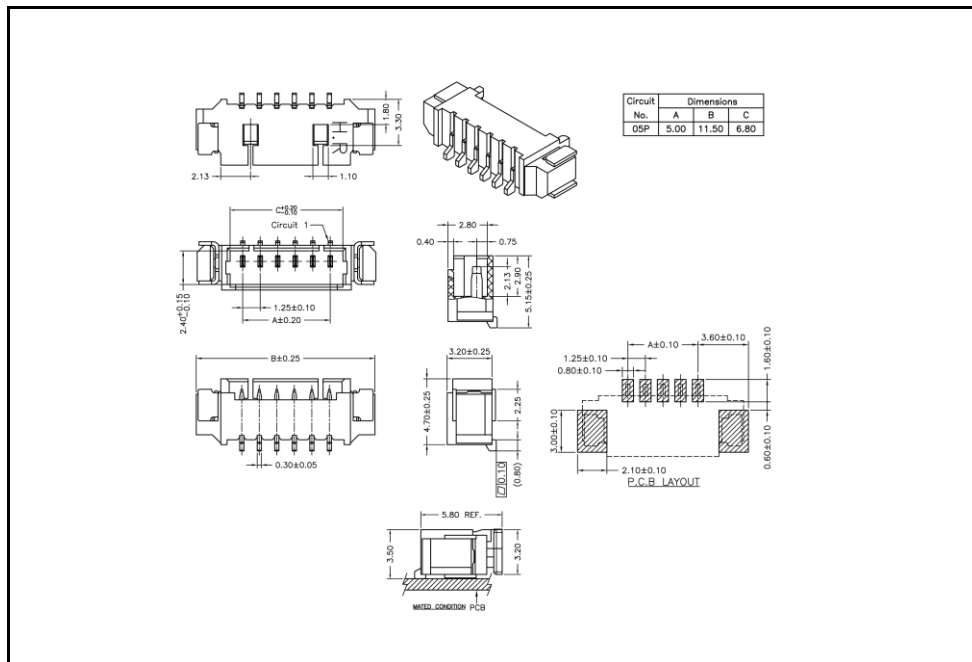

Figure 6: ACM1252U-Y USB Connector (Male) Specification

Note: Connector on **Figure 6** is attached to the PCB.

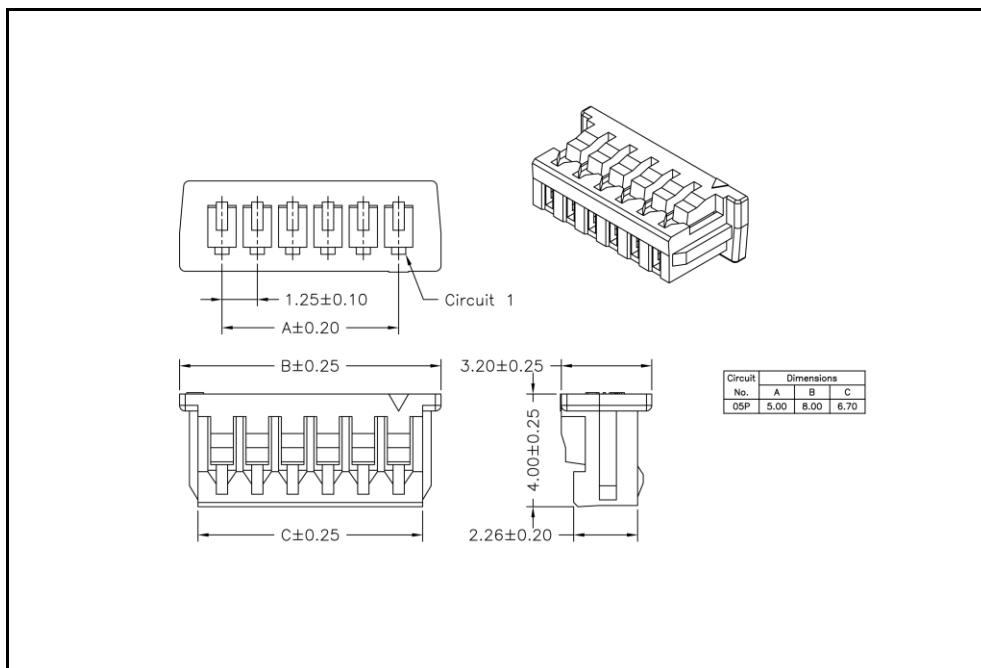

Figure 7: ACM1252U-Y Cable Connector (Female) Specification