



CONTACTLESS READERS

ACR1552U

USB NFC Reader IV

ACR1552U USB NFC Reader IV is the fourth generation of USB NFC Reader developed based on 13.56 MHz contactless technology. It can access contactless cards and devices following the ISO 14443 Type A and B, ISO 15693, and ISO 18092 standards.

Compliant with both CCID and PC/SC standards, this plug-and-play NFC reader is equipped with a high-speed communication capability of up to 848 kbps. The reader has USB firmware upgradability and extended contactless APDU commands, making it versatile and cost-effective hardware for various industries, such as finance, healthcare, and government.

It also offers intelligent support for three modes of NFC features: reader/writer, card emulation, and keyboard emulation. The flexibility of NFC readers allows for various potential applications, such as e-payment, access control systems and transportation ticketing.

KEY FEATURES

- ✔ **Support various contactless card type**
 - ISO 14443 Type A & B Parts 1-4
 - ISO 15693
 - ISO 18092 NFC
 - MIFARE® (T=CL), FeliCa, NFC Tags
 - SRI/SRIX, CTS, Innovatron, Picopass, Topaz Card
- ✔ **Performance**
 - Read/Write ISO 14443A & B speed of up to 848 kbps
 - Read/Write ISO 15693 speed of up to 53 kbps
- ✔ **Support various NFC features**
 - Card Reader/Writer Mode
 - Card Emulation Mode
 - Keyboard Emulation Mode
- ✔ **Security**
 - 1 x ISO 7816 Standard SAM slot for improved security
- ✔ **Support USB Firmware Upgrade**
- ✔ **Reliable**
 - Certified for international regulations
 - Mean time between failures (MTBF) up to 500k Hours
 - Short Circuit Protection
- ✔ **Compatibility**
 - Support for all major operating systems
 - Windows®, Linux®, macOS, Android™



Common Applications

- e-Government
- e-Banking and e-Payment
- e-Healthcare
- Transportation
- Network Security
- Access Control
- Loyalty Program
- Smart Poster/URL Marketing





TECHNICAL SPECIFICATION

Contactless Smart Card Interface	
Supported Card Types	ISO 14443 Type A & B Parts 1-4, ISO 15693, ISO 18092 NFC, MIFARE®, FeliCa, SRI/SRIX, CTS, Innovatron, Picopass, Topaz Card
Operating Frequency	13.56 MHz
Reading Distance	Up to 70 mm (Depending on tag type)
Read/Write Speed	106/212/424/848 kbps (ISO14443) 26/53kbps (ISO15693)
Supported NFC Mode	Card Reader/Writer, Keyboard Emulation, Card Emulation
SAM Card Interface	
Standard	1 x ISO 7816 Class A (5V) Standard SIM size slot
Read/Write Speed	13.4 kbps – 1,250 kbps
Clock Frequency	5 MHz, up to 10MHz (Upon request)
Protocol	T=0, T=1
Host Interface	
Protocol	USB CCID
Connector Type	USB Type-A
Speed	USB 2.0 Full Speed (12 Mbps) compatible with USB 3.0
Supply Voltage	5VDC
Current Consumption	Max. 300mA
USB Firmware Upgrade	Supported

Physical Characteristics	
Dimension (L x W x H)	Main Body: 98.0 x 65.0 x 12.8 mm Antenna size: 50.0 x 40.0 mm
Weight (±5 g)	79 g (USB Type-A)
Available Colour	White
USB Cable Length	1 m (Non-detachable)
Peripherals	
Buzzer	1 x Programmable Buzzer (Mono-tone)
LED	1 x Programmable LED (Blue & Green)
Operating Condition	
Temperature	0 - 60°C
Humidity	90% (Non-condensing)
MTBF	500,000 Hours
Certifications & Compliances	
Certifications	IEC/EN 62368, CE, UKCA, FCC, VCCI, KC, RoHS, REACH, WEEE, J-LIS Microsoft® WHQL
Compliances	USB CCID, PC/SC
Libraries & Tools	
Libraries	CT-API
Tools	Software Development Kit
Drivers & Support	
Driver Supported OS	Windows®, Linux®, macOS, Android™
Warranty	1 Year
Model/Part Number	
USB Type-A	ACR1552U-M1
USB Type-C	ACR1552U-MF

MECHANICAL SPECIFICATION

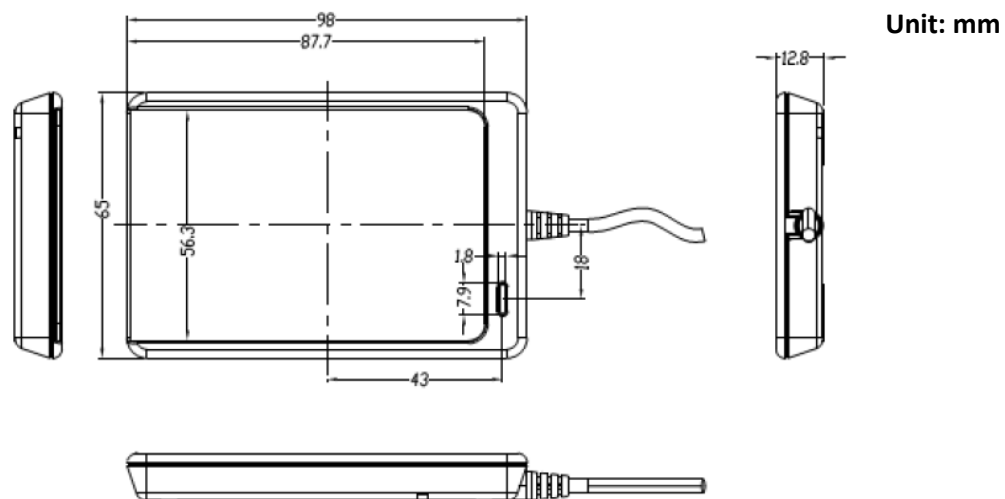

About ACS

Advanced Card Systems Ltd. (ACS), founded in 1995, is Asia Pacific's top supplier and one of the world's top 3 suppliers of PC-linked smart card readers. ACS is the winner of the Product Quality Leadership Award for Smart Card Readers from Frost & Sullivan. In 2010, 2014 and 2015, ACS was listed in Forbes Asia's "Best Under a Billion" list, an inter-industry list comprised of 200 top-performing publicly listed companies in the Asia-Pacific, with sales between US\$5 million and US\$1 billion. ACS develops a wide range of high-quality smart card reading/writing devices, smart cards and related products and distributes them to over 100 countries worldwide.

Click [here](#) for Sales Enquiry
Tel: +852-2796-7873
Fax: +852-2796-1286

macOS is registered trademarks of Apple Inc., registered in the U.S. and other countries.
Windows® is a trademark of Microsoft Corporation in the United States and/or other countries.
Android™ is trademarks of Google LLC.
Linux® is the registered trademark of Linus Torvalds in the U.S. and other countries.

